

L3+_HashBoard_72_V1.6.1	
10v, VDD POWER SUPPLY	Rev 0.1
3-5-2022	RDC
Filename	Sheet 1

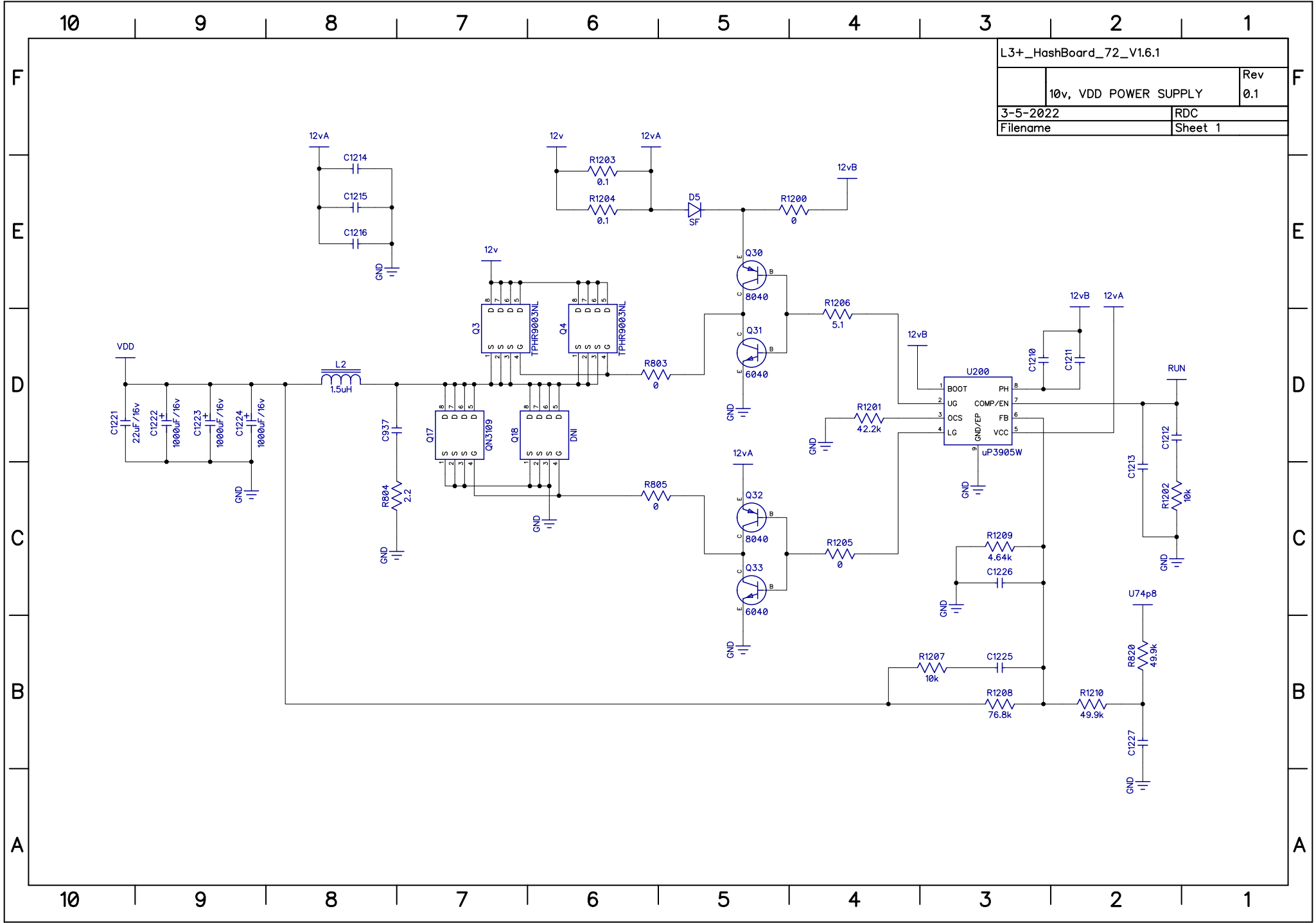

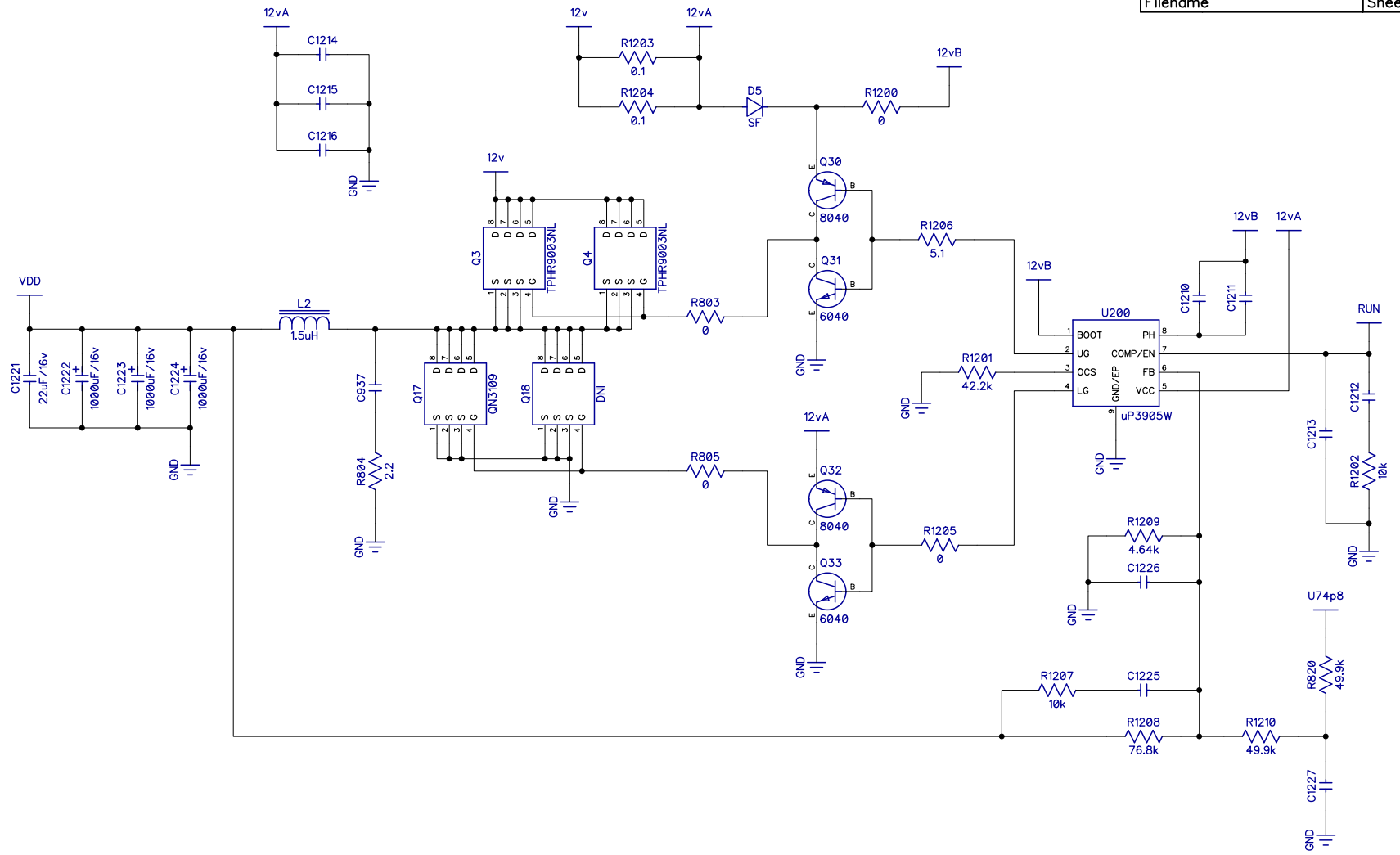
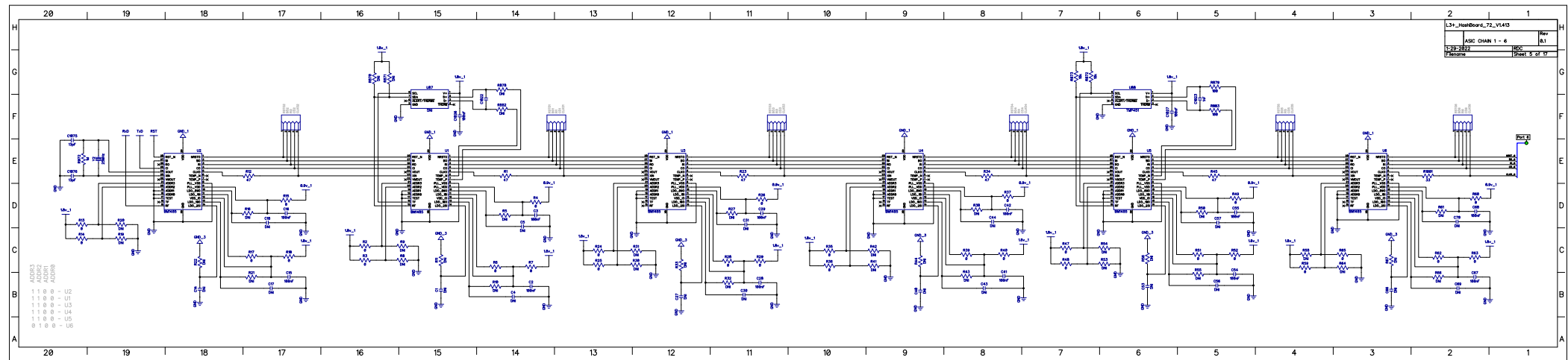

0 --- ADDR3
 1 --- ADDR2
 2 --- ADDR1
 3 --- ADDR0
 4 --- CS1
 5 --- CS2

L31_HostBoard_72_V1413		
ADC CHAN 1 - 0	Rev	B.1
1/22/2017	Doc	
Flanone	Sheet 5 of 17	

L3+_HashBoard_72_V1.413		Rev
1.8v / 0.9v LDO REGULATORS		0.1
1-29-2022	RDC	
Filename	Sheet 4 of 17	

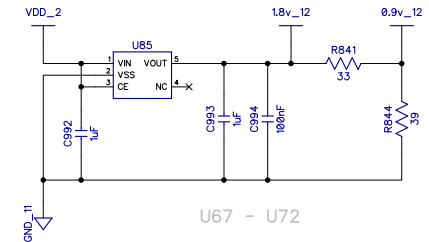
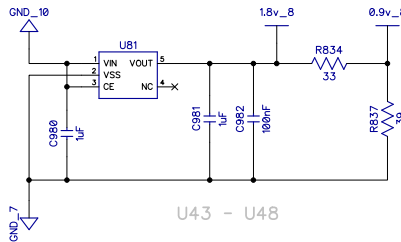
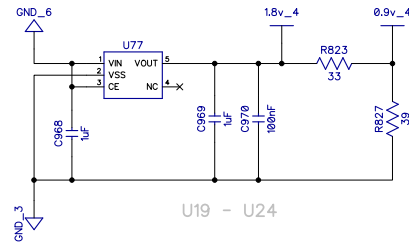
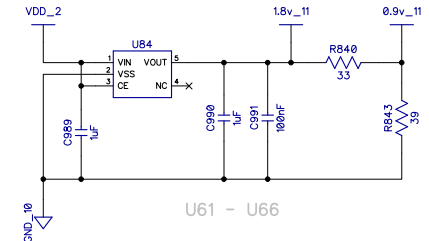
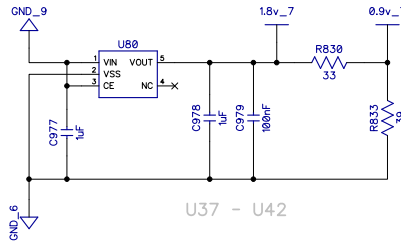
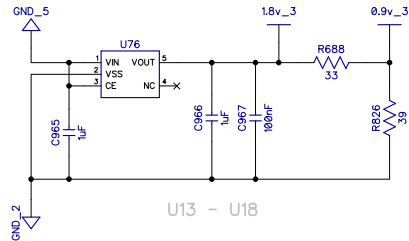
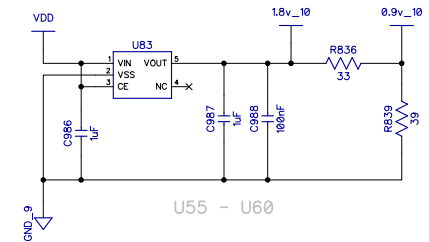
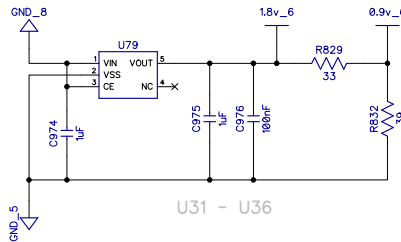
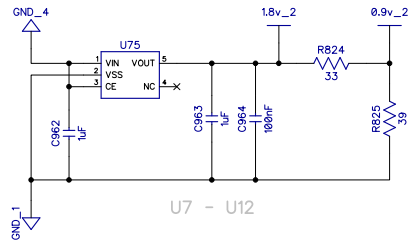
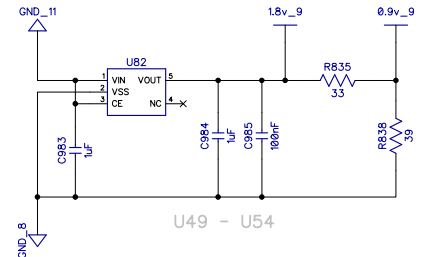
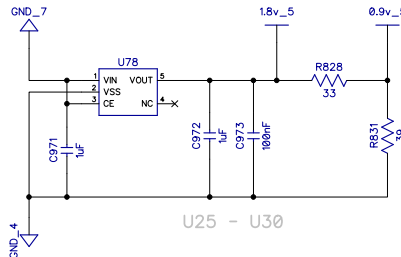
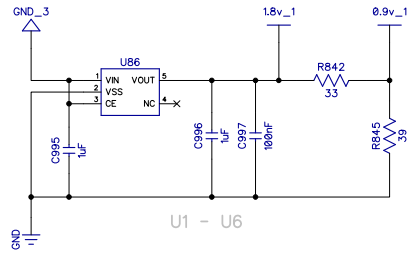

L3+_HashBoard_72_V1.413	
14v, VDD2 POWER SUPPLY	Rev 0.1
1-29-2022	RDC
Filename	Sheet 3 of 17

